

ADVANCES IN  
EXPERIMENTAL  
MEDICINE  
AND BIOLOGY

---

Volume 629

# Behavioral and Neurophysiological Aspects of Target Interception

Hugo Merchant, Wilbert Zarco, Luis Prado, and Oswaldo Pérez

**Abstract** This chapter focuses on the behavioral and neurophysiological aspects of manual interception. We review the most important elements of an interceptive action from the sensory and cognitive stage to the motor side of this behavior. We describe different spatial and temporal target parameters that can be used to control the interception movement, as well as the different strategies used by the subject to intercept a moving target. We review the neurophysiological properties of the parietofrontal system during target motion processing and during a particular experiment of target interception. Finally, we describe the neural responses associated with the temporal and spatial parameters of a moving target and the possible neurophysiological mechanisms used to integrate this information in order to trigger an interception movement.

## Introduction

The world is a dynamic environment where people and animals usually interact with objects in relative motion (i.e. organisms are moving in the environment and/or objects are moving within the visual field toward organisms). For example, animals walk, jump, and run; people and vehicles move, fly, and sail; and objects can be thrown, fall under gravity, or may be blown by the wind. From this perspective, there are two main types of interactions with objects in relative motion: collision avoidance, and the opposite, an interception. Successful control of these interactions is essential for survival. Fatal encounters can happen if the organism is not able to avoid collision or a predator, and a predator will eventually die if not capable of catch its prey. This huge adaptative pressure suggests that the neural mechanisms underlying collision avoidance and interception have been sculpted by evolution throughout millions of years.

---

H. Merchant (✉)

Instituto de Neurobiología, UNAM, Campus Juriquilla, Querétaro Qro. 76230

México, USA

e-mail: merch006@umn.edu

An interception can occur in a variety of ways and can be classified in two main categories: interceptions in which the object is captured or caught, and interceptions in which the object is contacted or hit. The former involves complex movements of the arm and especially the hand. In the latter, preprogrammed movements with movement times below 500 ms are usually executed. Evidently, a successful interception demands that the target object (a ball, a surface, a prey) and the intercepting effector (hands, feet, jaws) meet at the same location (spatial matching) and at the same time (temporal matching). Thus, the guidance of effector movements to their target destination requires some extrapolation (predictive strategy) or reaction (reactive strategy) using key sensory signals so that proper movement adjustments can be done to cope with task demands. After more than 15 years of psychophysical research on interception, different spatial and temporal variables have been shown to be involved in the control of the interception movement. Even more important has been the general observation that the relative importance of these variables on interceptive behavior is highly dependent on the context in which the interception is performed.

This chapter focuses on the behavioral and neurophysiological aspects of manual interception. Before presenting an experiment that examines manual interception we review the variables that are critical to control interceptive action in a variety of contexts. We also provide an overview of the neurophysiological properties of the parietofrontal system during visual motion processing as well as during the particular action of target interception.

## **Psychophysics of Interceptive Behavior**

A myriad of interceptive actions can be performed that vary with: (1) the properties of the target (its shape and how it is moving), (2) whether the target is caught or hit, (3) the properties of the effector movement, and (4) the precision constraints on the interception. Interceptions requiring locomotion, like running to catch a ball, or interceptions where the target is pursued for a long time are behaviors where it is more challenging to explicitly identify timing and positional variables. It is the covariation between temporal and spatial variables that makes these behaviors difficult to study in behavioral and neurophysiological terms. Hence, in this chapter we focus on the simpler example of manual hitting interceptions, where the control of movement can rely on explicit representations of where to go (the interception zone IZ) and how long it will take to get there (time-to-contact TTC). Thus, in this type of behavior the time and position information are clearly distinguishable.

As we mention above, a successful interception demands that the target and the intercepting effector meet at the same time at the same location IZ. Regarding the spatial aspect, the number of directions in which the target and the hitting effector can approach each other are in principle infinite. Five basic

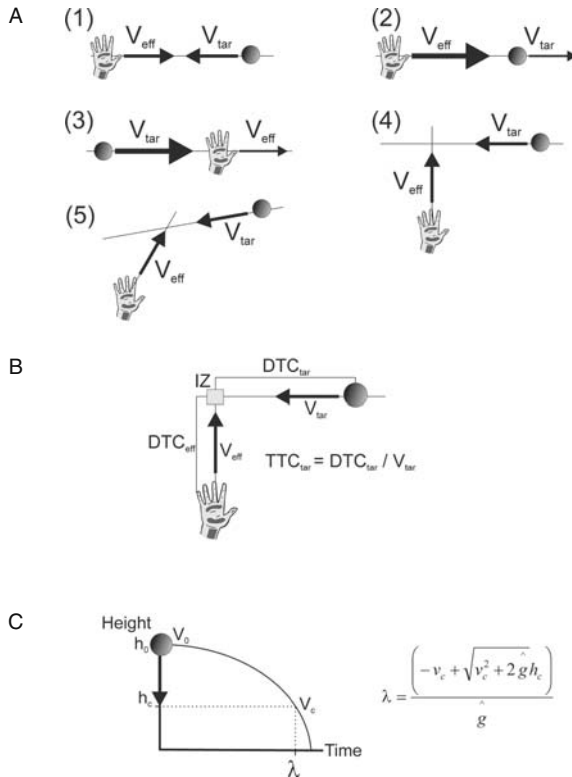

**Fig. 1** **A.** Interception directions. Linear approach configurations between the target and the interception effector (see text for details). **B.** Target and effector time-to-contact ( $TTC_{tar}$ ,  $TTC_{eff}$ , respectively) are computed as the first order estimate of object motion because it incorporates information about object distance ( $D$ ) from the interception zone ( $IZ$ ), and its velocity ( $V$ ). **C.** A vertically falling target is changing its height ( $h$ ) and velocity ( $v$ ), which implies acceleration caused by gravity. An interception movement is triggered when the time remaining has decreased to a critical value of lambda ( $\lambda$ ). This variable provides a second-order approximation of target motion, because it incorporates information about target distance and velocity, and it always assumes that the target is accelerated by gravity ( $\hat{g}$ )

linear approach directions for manual hitting interceptions can be distinguished (Tresilian, 2005, see Fig. 1A): (1) Direct collision, (2) pursuit where the target is hit by the intercepting effector along the same path and direction, (3) receding, where the target heads towards a slower moving effector, (4) perpendicular approach, and (5) vector combinations of pursuit and perpendicular configurations, or direct collision and perpendicular configurations.

Considering the temporal dimension, a target can be hit in a particular location only if the time remaining before the effector reaches that location is equal to the target’s remaining time to reach the same location. The time remaining is called *Time-To-Contact* or *TTC*, and in successful hitting interceptions, *TTC* of the effector ( $TTC_{eff}$ ) must be equal or very similar to the *TTC*

of the target ( $TTC_{tar}$ ) (Fig. 1B). Finally, for interceptions of falling objects gravity also needs to be taken into consideration, in addition to the object's velocity ( $v_o$ ) at the drop height ( $h_o$ ) and the distance to the contact ( $c$ ). An interception movement is triggered when the time remaining has decreased to a critical value of lambda,  $\lambda$  (Fig. 1C, for more explanation below).

Predictive and reactive models have formalized the integration of the temporal and spatial variables involved in the perceptual and motor components of the interceptive action. In the predictive model, the interception movement is predetermined and is not influenced by visual information after the motor command is triggered. Interceptions with fast and ballistic movements are accounted for by this model. In the reactive or on-line control model, the effector movement is influenced by visual information even after the motor commands have been issued. Target pursuit is a behavior well explained by this model. In both models, the effector movement is controlled by a cortical motor pattern generator (MPG) that issues descending motor commands to the spinal cord (Tresilian, 2004).

### *Predictive Model*

A predictive strategy involves producing a short movement with a predetermined movement time in order to cope with situations in which a response cannot rely on sensory feedback due to the delay and inaccuracies of sensory systems. In this model, it is assumed that the programmed movement time ( $MT_{prog}$ ) is triggered after a key target parameter reaches a particular threshold (Fig. 2A). As we review below, different key parameters are used depending on the interceptive circumstances. However, the model also considers two additional processing times before the threshold value. The first interval is the time of visual information transmission from the retina through the nervous system to the motor areas of the frontal lobe, areas that correspond to the MPG. This interval is called perceptual transmission time (PT). The second one is related to the time required for the MPG to produce the muscular contraction. This time is called transmission time (TT) and includes the transmission times from the cortical command to the spinal cord, from the motor neurons to the muscles, and the time needed for muscle contraction once the command has been received. Thus, the MPG should begin to issue commands when a key parameter ( $DTC_{tar}$ ,  $TTC_{tar}$ , or  $\lambda$ ) equals to  $MT_{prog} + PT + TT$ . The critical value of the key parameter is called the  $CRIT_{val}$  (Fig. 2B; Tresilian, 2005). In some situations it has been observed that the key parameter is the distance remaining to get to the interception zone ( $DTC_{tar}$ ) (Fig. 1B). In this case, the interception response is triggered when the target has reached a certain  $DTC_{tar}$  threshold. Evidence for this parameter to be key for the control has been provided in some hitting and plunging tasks (van Donkelaar et al. 1992; Wann 1996). Note, though, that distance  $DTC_{tar}$  provides a zero-order approximation of target

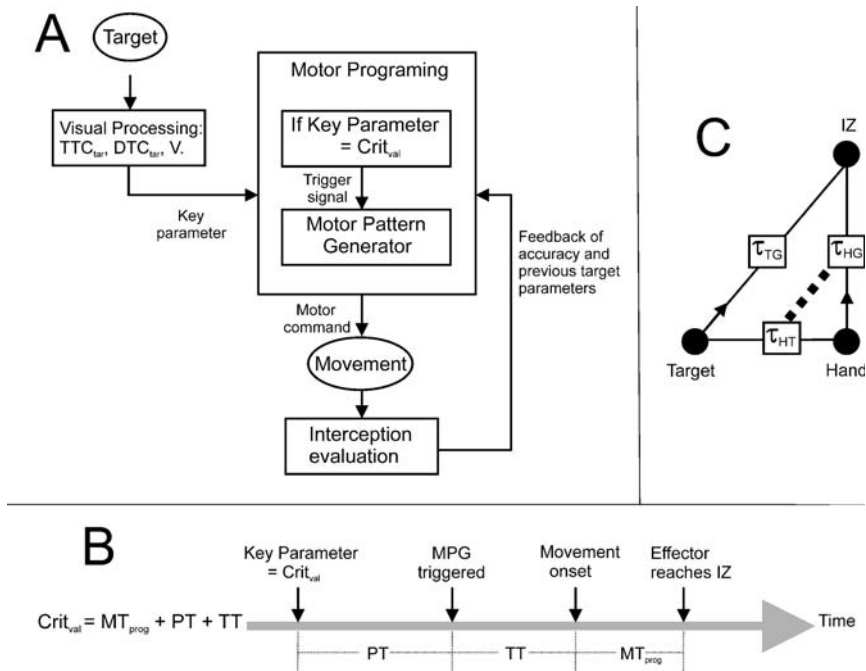

**Fig. 2** **A.** Flow diagram of the basic elements of the predictive model. **B.** Sequence of events involved in the predictive model.  $MT_{prog}$ : Programmed movement time; PT: perceptual transmission time; TT: transmission time; IZ: interception zone. **C.** Reactive model using Tau-coupling during an interception task. The target moved at various constant velocities, accelerations, or decelerations toward the interception zone, IZ, and the subject had to move the hand cursor so that it stopped at the goal as the target arrived there. Participants solved the task by tau-coupling  $\tau_{HT}$  and  $\tau_{HG}$ . The  $\tau$  values are the time-to-closure at the current closure rate of the gaps HT and HG between target, hand and goal. Modified from Merchant & Georgopoulos, 2006

motion because it only includes information about current distance of the target but ignores velocity and acceleration.

In most of the hitting interceptions the key parameter is the  $TTC_{tar}$  (Fig. 1B). The  $TTC_{tar}$  provides a first-order approximation of target motion because it incorporates information about target distance and velocity but ignores acceleration. David Lee (1976) postulated that the  $TTC_{tar}$  could be easily computed using an optical variable called tau ( $\tau$ ), originally defined as the ratio of the size of the retinal image at a given time to the rate of expansion of the image. Since then it has been shown that  $TTC_{tar}$  can be computed using different monocular and binocular cues (Tresilian, 1999; Wann 1996). The critical value of tau used to initiate a movement was originally assumed to be invariant for a particular interceptive task (Lee, 1976). In some interceptive situations this can be true, like the constant tau value at which gannets close their wings just before entering the water (Lee & Reddish, 1981). However, in most cases the

movement time, and therefore the threshold  $TTC_{tar}$ , varies as a function of different parameters of the target. Hence, the predictive mechanism is able to preprogram the threshold  $TTC_{tar}$  and the  $CRIT_{val}$  in accord with other parameters of the target. One of these parameters is the target velocity. Subjects make briefer and/or faster interception movements when the target moves more quickly (Mason & Carnahan, 1999; Tresilian & Lonergan, 2002; Merchant et al., 2003b; Brouwer et al., 2000; Gray, 2002a). In addition, movement time is also affected by the target viewing time; shorter movement times are observed when viewing times are shorter (Mason & Carnahan, 1999; Merchant et al., 2003b; Tresilian & Houseman, 2005).

The final key parameter in this review is lambda ( $\lambda$ ). This is a parameter that provides a second-order approximation of target motion because it incorporates information about target distance and velocity, and always assumes that the target is accelerated by gravity (Fig. 1C). In behaviors such as catching or hitting a vertically falling target object, the interceptive response is triggered when  $\lambda$  reaches a particular threshold (Lacquaniti et al., 1993; Zago et al., 2004,; Zago & Lacquaniti, 2005). It is important to mention that in order to compute  $\lambda$ , actors need to use explicit information about the initial target height and velocity ( $h_0$  and  $v_0$ ), distance to contact ( $h_0$  to  $h_C$ ), and velocity at contact ( $v_C$ ). However, they also use an implicit knowledge or an internal representation of gravity ( $\hat{g}$ ) since it has been demonstrated that this parameter cannot be computed by the visual system (Zago & Lacquaniti, 2005).

It is important to consider that the accuracy constraints on the interception have an effect on the  $CRIT_{val}$  of the key parameter. When the task places more emphasis on temporal accuracy, movement time decreases as a function of the accuracy demands (Tresilian et al., 2003). The decrease in the threshold value and the concomitant decrease in movement time may improve temporal accuracy for two reasons: the durations of briefer movements are more controllable because there is less time for internal noise and external disturbances to affect execution. Second, moving more quickly implies that it is possible to see the target for a longer period beforehand such that the actor can obtain better information about its motion parameters (Tresilian, 2005). In contrast, when the interceptive action demands more spatial accuracy, movement time increases following the well-known trade-off between movement speed versus accuracy described as Fitts' Law (Fitts, 1954).

In summary, the predictive mechanism is affected by the type of interception that the actor is performing. When programming movement time the actor must store which key parameter to use, the  $CRIT_{val}$ , and the different constraints on prediction that depend on the interception context. One way of coping with this complex problem is to use information from previous interception attempts. In fact, it has been shown that programming movement time is affected by previous parameters of the target (De Lussanet et al., 2001; Gray, 2002a,b) and by an a priori guess about the causes of motion (Zago et al., 2004). Furthermore, the interceptive action improves with the overall accumulated experience.

### ***Reactive Model***

The reactive strategy assumes that the interception movement starts at a target traveling time or distance, and then is further modulated in an ongoing fashion (Van Donkelaar et al., 1992; Lee, 1998). The continuous control of an interception movement can be achieved using a concept also proposed by David Lee called tau-coupling (Lee, 1998). In this further development of tau, a continuous movement can be regarded as the closure of gaps: the gap between the effector and the target, the gap between the target and the interception zone, and the gap between the effector and the interception zone. This model states that the guiding control depends on tau-coupling, i.e. keeping two or more changing taus in a constant ratio. Thus, tau-coupling could be used to synchronize movements and regulate their kinematics. Indeed, it has been demonstrated that tau-coupling was used to guide the effector movement in an interception task by keeping the tau of the gap between the hand and the target coupled with the tau of the gap between the hand and the interception zone or goal (Fig. 2C; Lee et al., 2001). In this task, the subjects performed complex movements that were divided by submovements in response to a target that could move with one of 18 combinations of three acceleration types (constant acceleration, constant deceleration, and constant velocity) and six target movement times, from 0.5 to 2.0 s. In addition, the targets could move from the lower right or left of the monitor with an angle of 45 towards the interception zone (Port et al., 1997; Lee et al., 1997). In such interception conditions, a predictive strategy triggering ballistic movements was not useful. Instead, a reactive response based on tau-coupling was used, achieving the required degree of accuracy (Port et al., 1997).

### **Neurophysiology of Interception**

Taken as a whole, the studies in experimental psychology have indicated that there is a set of requirements to be satisfied to intercept a moving target. First, it is necessary to process the visual motion information of the target, including its actual position, TTC, direction, and velocity. Second, the subject uses a predictive or reactive strategy to control the initiation of the interception movement so that at the end of the movement the target is intercepted. Third, an interception movement should be implemented. This can be a ballistic movement with a predetermined direction and kinetics, or it can be a complex movement divided into sub-movements that can be regulated to optimize the precision of the interception. Finally, it is necessary to evaluate the end result of the interception, i.e. whether it was sufficiently precise. This information can be used to correct the strategy and the interception movement properties.

Several of these aspects have been studied separately at the neurophysiological level. It is well known that different cortical and subcortical areas, such as the middle temporal area, MT, process visual motion information. It has also



been demonstrated that the different premotor areas and the primary motor cortex are involved in the preparation and execution of voluntary movements (Georgopoulos, 2000; Wise et al., 1997). Finally, it has been suggested that different areas of the parietal and frontal lobes are engaged in visuomotor transformations (Battaglia-Mayer et al., 2001). In the following we show how the visuomotor information is integrated in two areas of the parietofrontal system during an interception task (Merchant & Georgopoulos, 2006). Before presenting the experimental results, we will focus on the neural mechanisms processing the key target parameters throughout different visual motion areas of the brain.

### *Neurophysiology of $TTC_{tar}$*

The neural representation of  $TTC_{tar}$  has been described in the pigeon and the locust. In these studies, approaching objects were simulated by looming stimuli. In pigeons, different types of looming-sensitive neurons were found in the nucleus rotundus, each computing a different optical variable related to image expansion of objects approaching on a direct collision course (Rind & Simmons, 1999; Sun & Frost, 1998). One group of neurons signals the  $TTC_{tar}$  using tau, and a second group signals the absolute rate of expansion. The absolute rate of expansion and  $TTC_{tar}$  are probably used to provide an early warning of approaching objects. In the locust, similar neural response types were described (Judge & Rind, 1997; Hatsopoulos et al., 1995). Hence, there is direct evidence that  $TTC_{tar}$  is represented explicitly in the nervous system.

### *Visual Motion Processing*

Visual motion is a powerful stimulus for activating a number of brain areas (see Fig. 3). Neurophysiological studies in monkeys (Andersen, 1997; Newsome et al., 1990) and functional neuroimaging studies in human subjects (Cheng et al., 1995; Zeki et al., 1991) have documented the involvement of several areas in stimulus motion processing, including the middle temporal area MT (Zeki, 1974), medial superior temporal area MST (Van Essen et al., 1981), the superior temporal polysensory area (Bruce et al., 1981), area 7a (Motter and Mountcastle, 1981; Siegel and Read, 1997; Merchant et al., 2001), and the ventral intraparietal area (Colby et al., 1993). More detailed analyses of the neural mechanisms underlying visual motion processing have been performed in monkey experiments, the results of which indicate that different areas relate to different aspects of this processing. The direction of rectilinear motion is explicitly represented in the neural activity of MT, a structure that projects to MST, areas 7a and 7m, and VIP. These target areas are part of the posterior parietal cortex (PPC). In turn, cells in MST and area 7a not only respond to

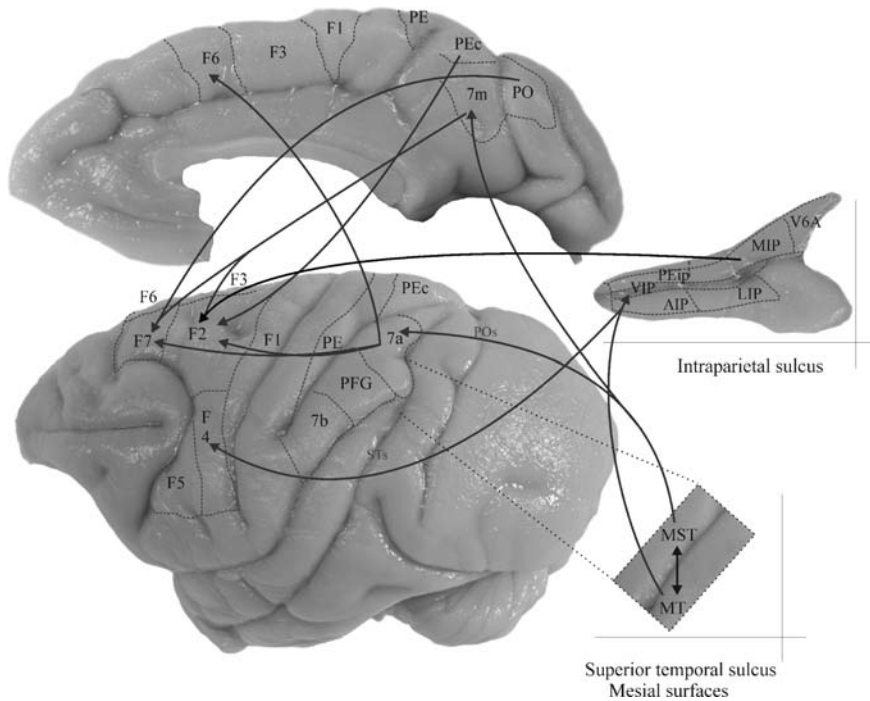

**Fig. 3** Visual motion inputs from posterior parietal areas to premotor areas constituting a parietofrontal distributed system for target interception (Marconi et al., 2001; Matelli & Luppino, 2001)

rectilinear motion, but also to optic flow stimuli including stimulus motion in depth (Duffy & Wurtz, 1991; Siegel & Read, 1997; Merchant et al., 2001). Neurons in MST are tuned to the focus of expansion and can code for the direction of heading (Duffy & Wurtz, 1995; Bradley et al., 1996). The responses of area 7a neurons to optic flow stimuli appear to be more complex than those in MST, since individual neurons respond similarly to opposed directions of motion, like clockwise (CW) and counterclockwise (CCW) rotations, upward and downward motions, or rightward and leftward translations (Merchant et al., 2003a). Interestingly, optical expansion from stimuli moving towards the observer is the most prominent stimulus to drive the activity of neurons in this area. It is therefore reasonable to expect that PPC is a good candidate for the neural representation of tau in primates. In fact, our group was the first to characterize the neural correlates of  $TTC_{tar}$  in area 7a and the motor cortex in the monkey (see below). Furthermore, a recent fMRI study demonstrated that the parietofrontal system in humans is specifically activated during judgments of time to contact (Field & Wann, 2005). Besides the representation of TTC and direction of motion, areas such as MT, MST, and area 7a also code for the speed of visual motion (Maunsell & Van Essen, 1983; Duffy & Wurtz 1997;

Phinney & Siegel, 2000). In contrast, the visual system is not able to fully process acceleration of visual motion (Lisberger & Movshon, 1999).

Overall, the current knowledge of visual motion processing indicates that the motor system has access to the perceived  $TTC_{tar}$ ,  $DTC_{tar}$ , and target velocity in order to drive the interceptive response. This visual information travels to premotor areas and then to the primary motor cortex from different areas of the PPC, as depicted in Fig. 3. However, the visuomotor system has no access to target acceleration. Instead, acceleration produced by gravity is internally represented in the vestibular system (Indovina et al., 2005), and can be used by the motor apparatus for catching and hitting objects falling vertically. Therefore, the anatomic evidence indicates that the neural substrate of interceptive actions may be a distributed network engaging the parietofrontal system. In the next sections we review our studies on the neural correlates of target interception in two important nodes of the parietofrontal system: area 7a and the motor cortex.

### ***Neurophysiology of Interception for Circularly Moving Targets: The Task***

We examined interceptive actions of human subjects and monkeys during the interception of circularly moving targets. The task required the interception of a moving target at 6 o'clock in its circular trajectory by applying a downward force pulse on a pseudoisometric joystick that controlled a cursor on the computer monitor (Fig. 4A; Merchant et al., 2003b). The target moved counterclockwise with one of five speeds, ranging from 180 to 540 degrees/s. In addition to the real motion condition where the targets moved smoothly along a low contrast circular path giving continuous position information, we also used an apparent motion situation where the target was flashed successively at the vertices of a regular pentagon (Shepard & Zare, 1983). In the latter condition, an illusion of a stimulus continuously moving along the circular path was obtained at target speeds above  $\sim 315$  degrees/sec in human subjects (Merchant et al., 2005). We included path-guided apparent motion because we were interested in comparing the behavioral strategy and the neural mechanisms during the interception of real continuous and apparent moving stimuli. The hypothesis was that the neural underpinnings and key parameters for target interception are different during real and apparent motion conditions.

Regarding the interceptive behavior we found that interception errors, measured as the signed angular difference between the target and the cursor at the interception, increased linearly with target speed but were slightly larger in the apparent than in the real motion condition (Fig. 4B top; Merchant et al., 2003b). Early interceptions were produced for slowly moving targets and late interceptions for fast moving ones. This demonstrated that (a) subjects can intercept an apparent motion target but, compared with real motion, the

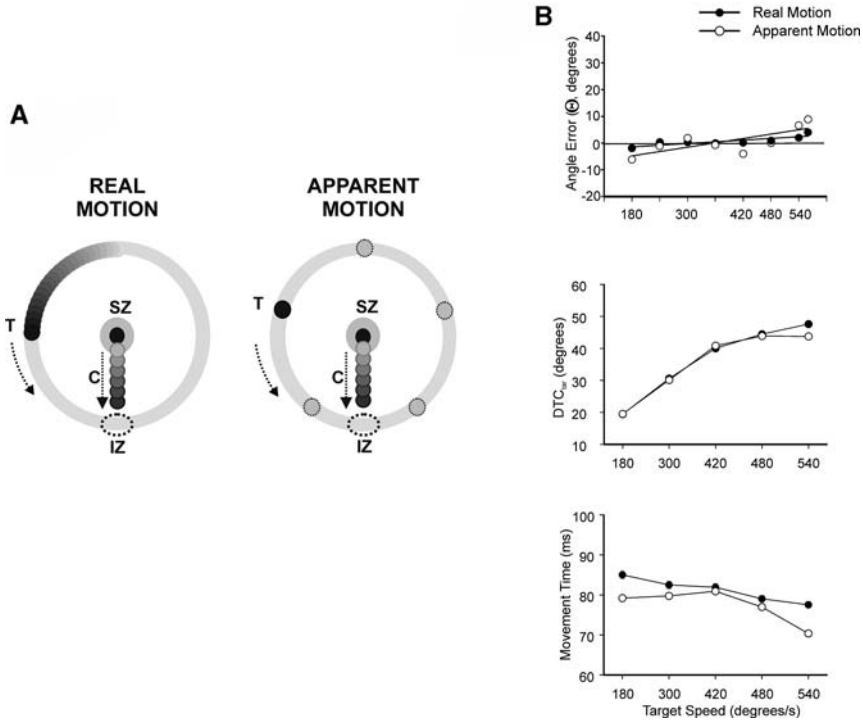

**Fig. 4 A.** Interception task of circularly moving targets. T represents the smoothly moving target in the real motion condition, or the flashing stimulus at the vertices of a regular pentagon in the apparent motion condition; C = cursor, SZ = starting zone, IZ = interception zone. **B.** Behavioral performance during the interception task as a function of the stimulus speed. *Top*, Angle error ( $\Theta$ ) of two monkeys; *middle*, target distance-to-contact ( $DTC_{tar}$ ) at the beginning of the interception movement; *bottom*, movement time. Filled circles correspond to the real motion and open circles to the apparent motion condition. Modified from Merchant et al., 2003b

performance is overall slightly degraded; and (b) direction of interception errors are similar in the two target motion conditions.

In this task the human subjects and monkeys produced very fast ballistic movements indicative of a predictive strategy. We could therefore investigate the possible key parameters used to control the initiation of the interception movement. For that purpose, we calculated both the time and the distance/angle to contact for the target at the beginning of the effector movement,  $TTC_{tar}$  and  $DTC_{tar}$ , respectively. We found that  $DTC_{tar}$  increased asymptotically as a function of the stimulus speed in both motion conditions (Fig. 4B middle). In addition, the movement time (that corresponded to  $TTC_{tar}$  in these conditions) decreased slightly as a function of the stimulus speed. It was longer in the real compared to the apparent motion condition (Fig. 4B bottom). Even though these parameters could be computed, it was difficult to unambiguously identify

which key parameter was actually used for interception. Nevertheless, as we will show below, the neurophysiological data collected in the parietofrontal system suggest the use of spatial cues, such as  $DTC_{tar}$  during real motion and the utilization of temporal cues, such as  $TTC_{tar}$  to trigger the movement in the apparent motion condition (Merchant et al., 2004b).

### ***Neurophysiology of Interception: Neural Representation of Space and Time in the Parietofrontal System During Visual Motion***

After having assessed the psychometric performance in our task, we proceeded to study the processing of visual motion in area 7a and the motor cortex during real and apparent motion. To better characterize movement specific and sensory specific contributions, we added a so-called NOGO task, where the monkeys watched the same two types of stimuli for two seconds but did not produce an interception response. The results revealed two populations of neurons in area 7a that were active (Merchant et al., 2004a). The first population comprised cells whose activity was tuned to the angular location of the circularly moving stimulus responding in a particular region of the circular trajectory of the stimulus (Fig. 5A). Interestingly, most of these responses were selective for real motion; further, all angular positions were represented in the population.

The second population of area 7a cells was selective for apparently moving stimuli and showed a periodic activation entrained with the period of the interstimulus interval of the flashing dots (Fig. 5B) showing significant harmonics to the interstimulus interval frequencies in the spectral analysis (Merchant et al., 2004a). This may reflect a simple passive visual property of neurons in this area, namely that every time that a stimulus is flashed there is a neural response. The successive onset and termination of nearby flashes then may induce the illusion of apparent motion. Alternatively, it is possible that these “periodic” neurons may be involved in time perception such that they may also create a temporal framework where time intervals can be perceived and used to drive the subject’s behavior (Merchant et al., 2004a). In summary, the neurophysiological results indicate that in area 7a during the NOGO task, there were at least two different levels of neural representation of the circularly moving stimuli: (a) the angular position of the stimuli in the real motion condition; and (b) the temporal sequence of flashed stimuli in the apparent motion condition.

In the motor cortex, a substantial population of neurons showed a selective response to real moving stimuli – even in the absence of a motor response (NOGO). This activity was modulated in some cases by the stimulus speed and some of the neurons were tuned to the angular position of the stimulus (Merchant et al., 2004a). Again, all of the angular positions were represented in the population showing that the motor cortex has continuous access to spatial information of visual motion supporting that this information is of critical

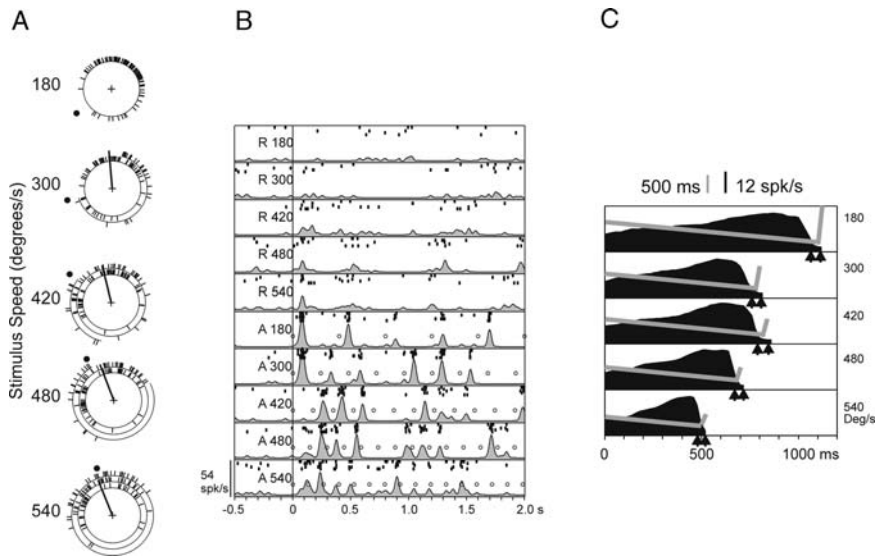

**Fig. 5** **A.** Circular raster of a neuron in area 7a with a significant preferred stimulus angular location for all stimulus speeds in the real motion condition. The vector from the center cross to the circular raster represents the significant preferred stimulus angular location. **B.** Neuron in area 7a that showed a clear periodic response entrained to the flashed stimuli (represented as open circles) in the apparent motion condition for all five speed conditions (A: apparent motion; R: real motion; stimulus speed in deg/s.). For each target speed both the raster (*top*) and the spike density functions (*bottom*) are depicted. **C.** Motor cortical neuron with a response (SDF, in *black*) that was inversely proportional to the target time-to-contact (*gray line*) during the interception of apparent motion targets moving at five different speeds. The first and second arrows correspond to the beginning and end of the movement time. The activity was aligned to the beginning of the target presentation. Modified from Merchant et al., 2004b

ecological value (Gibson, 1979). Given that objects moving with respect to the subject can potentially demand an immediate action towards them in circumstances such as collision avoidance or interception, it is crucial that the motor system has access to the motion parameters of the objects to be able to react in a timely fashion (Lee, 1976).

An intriguing observation was that relatively few neurons responded to the apparent motion stimuli in the motor cortex (Merchant et al., 2004a). This suggests that the motor cortex has no access to temporal or spatial information of the apparent motion stimuli in the NOGO task. In contrast, we demonstrate in the next section that during the interception of apparent motion stimuli motor cortical cells responded. Hence, we will conclude that the activity of some motor cortical cells was closely related to  $TTC_{tar}$  that proved to be the behaviorally relevant variable in the apparent motion condition. As there is no interception in the NOGO task and this parameter is not a meaningful variable, the motor cortical cells did not respond during this motion condition.

## ***Neurophysiology of Interception: Stimulus-dependent Encoding of Angular Position and tau***

We progress to compare the functional properties of neurons during the NOGO and the interception tasks. The objective was to identify the neural ensembles that were associated with the processing of visual motion, the implementation of the interceptive response, and the visuomotor transformations requisite for the target interception. The results showed, first, that one group of neurons in both the motor cortex and area 7a responded not only during the interception but also during the NOGO task (Fig. 6, for details see figure caption). Most of these neurons were tuned to the angular position of the stimuli. This type of neurons was more common in area 7a than in the motor cortex suggesting that area 7a is closer to the visual motion processing than the motor cortex. A second group of cells responded during the interception but not during the NOGO task. This type of response was observed more frequently in the motor cortex than in area 7a and was probably engaged in the sensorimotor transformations and the implementation of the motor response (Merchant et al., 2004b).

The task comparison revealed that, despite the fact that the neurons in the motor cortex responded to visual motion stimulation, most of the motor cortical cell activity was driven by the interception movement. This contrast, the neural activity in area 7a was mostly engaged by the sensory aspects of the

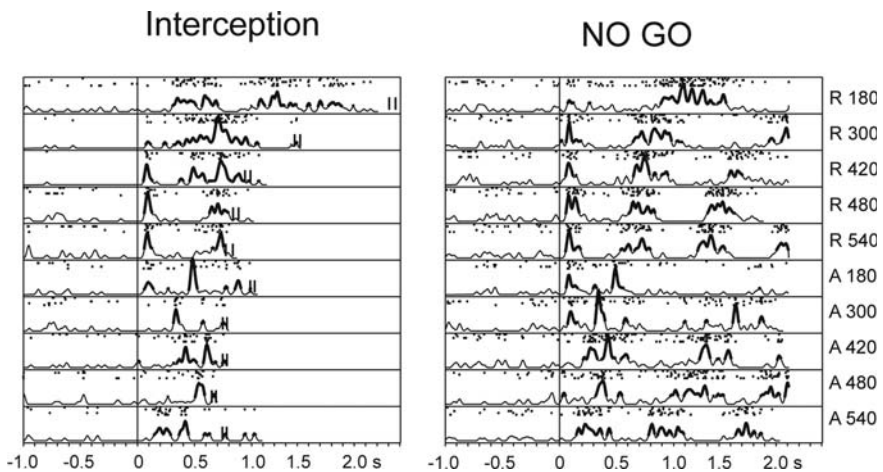

**Fig. 6** Rasters of spike trains and mean spike density functions (SDF) for each motion condition and stimulus speed for a neuron in area 7a during the interception and NOGO tasks. The illustrated neuron responded similarly for all motion conditions during the interception and the NOGO tasks. The neural activity of 5 trials was aligned with the onset of the stimulus movement at time 0. The **black bold** portions indicate that the SDF was greater than the mean + 3 SD of the control period. The two **vertical lines** in each raster of the interception condition represent the beginning and the end of the interception movement. R: Real motion; A: Apparent motion. Stimulus speed is in deg/s. Modified from Merchant et al., 2004b

interception task, and the neural responses in this area were tightly associated with the onset of the stimulus movement. This suggests that the sensorimotor transformations involved in the interception task include a parietofrontal distributed system that shows functional gradients. These functional gradients may be defined in large part by the connectivity of their elements (see Fig. 3; Mountcastle, 1978, Johnson et al., 1996; Battaglia-Mayer et al., 2001). Under this scheme, the PPC receives visual motion information, processes complex visual moving stimuli, and starts both the visuomotor transformation and the motor preparation. The PPC sends this information to the premotor and motor areas where the visual information is finally processed in order to generate a motor command (Fig. 3).

Next, we determined quantitatively the relation between the temporal pattern of neural activation and different aspects of the target and the motor execution during the interception task. We designed a multiple linear regression model to test the effects of different parameters on the time-varying neural activity (for details see Merchant et al., 2004b). The parameters that were tested are: stimulus position (direction cosines of the stimulus angle),  $TTC_{tar}$ , the vertical hand force, and the vertical hand force velocity (hand movements with the joystick were measured in force units). This regression analysis revealed that the time-varying neuronal activities in area 7a and in the motor cortex were related to different aspects of the stimulus and hand movement in the real and apparent motion conditions (Fig. 7). Results showed that in the real

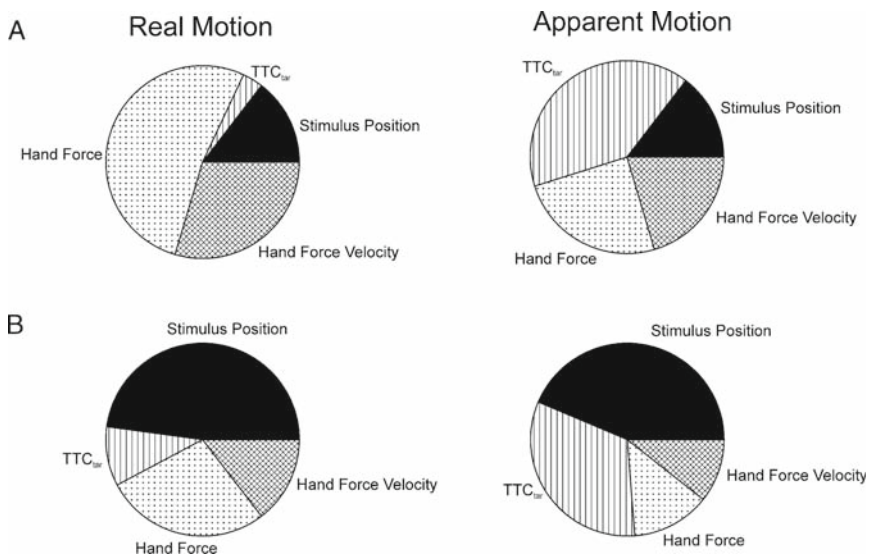

**Fig. 7** Percentages of neurons in the real and apparent motion conditions, for which the noted parameter was ranked first using the standardized coefficients obtained from the multiple regression analysis. **A:** Motor cortex. **B:** Area 7a. Modified from Merchant et al., 2004b



motion condition hand-related activity prevailed in the motor cortex (Fig. 7A) and stimulus-related activity prevailed in area 7a (Fig. 7B). In the apparent motion condition, on the other hand, neural activity was tightly correlated to  $TTC_{tar}$ , particularly in the motor cortex, and additionally with the stimulus position in area 7a (Merchant et al., 2004b).

The prevalence of stimulus position signals during the real motion situation in the multiple regression analysis suggests that neural populations in the motor cortex and area 7a were engaged in processing the stimulus position over time, and that this information was probably used to trigger the interception movement in the real motion condition. This hypothesis is supported by the finding that motor cortical neurons were modulated by the stimulus position during the real but not during the apparent motion conditions in the NOGO task (Merchant et al., 2004b).

$TTC_{tar}$  was the most important parameter in apparent motion interceptions in the motor cortex, and it was the second most important in area 7a, preceded by the stimulus angle. This is the first time that a neural correlate of the first-order estimate of the time-to-arrival has been reported in primates. We assumed that in the apparent motion condition the animals intercepted a stimulus that was the perceptual “reconstruction” of motion based on a sequence of stationary stimuli (Merchant et al., 2005). In fact, the detection threshold for apparent motion in human subjects has been shown to be 314 deg/s. However, we cannot rule out the possibility that in this condition the monkeys used the timing between dots to solve the interception task. As reported above, a population of neurons in area 7a signaled the onset of the flashing dots during the NOGO task (Merchant et al., 2004a). Consequently, it is possible that during the interception of apparent moving stimuli, the key parameter was  $TTC_{tar}$  rather than the stimulus location information. Figure 5C shows a motor cortical neuron in which  $TTC_{tar}$  was the most important parameter to account for the temporal variation in the neural responses. This neuron shows a linear increase in activity that was inversely proportional to the decrease in  $TTC_{tar}$ , and that reached the activity peak at a similar value of  $TTC_{tar}$  for different target speeds. This type of activity “ramp” is the representation of an elapsed-time accumulator, and in fact, it has been reported in PPC during a time interval discrimination task (Leon & Shadlen, 2003). Therefore, the  $TTC_{tar}$ -ramps recorded in area 7a and particularly in the motor cortex are a neural representation of time-to-contact that, once it reached a specific magnitude, can be used as the signal to trigger the interception movement.

As we observed that most of the neurons in both areas were significantly related to more than one parameter, we were also interested to determine whether particular combinations of variables were associated in the same cell with a frequency that was above chance. Specifically, we sought to establish whether the processing of sensory variables was associated with the encoding of motor variables, and whether there were differences in these relations between the real and apparent motion conditions in both areas. For that purpose, we performed a log-linear modeling analysis to find out which parameters showed

concurrent effects. The results showed that the association between the sensory and motor parameters was very different in the two areas under both motion conditions. In the motor cortex during the real motion condition, the hand force was significantly co-processed with the hand force velocity and the stimulus angle, whereas during apparent motion, the hand force was significantly coupled with  $TTC_{tar}$  and the hand force velocity. In addition, in area 7a for the real motion condition the stimulus angle was significantly co-processed with the hand force velocity, and  $TTC_{tar}$  was also significantly coupled with the hand force velocity. Finally, in the apparent motion condition, area 7a neurons showed significant co-processing of the stimulus angle and the hand force and force velocity. These results further support the existence of different mechanisms for interception of real and apparent motion targets. In the real motion condition the stimulus angle was the most important target variable and was co-processed with the hand force, whereas during the apparent motion the most important target parameter was  $TTC_{tar}$ , and it was co-processed with the hand force (Merchant et al., 2004b).

Taken together, these results indicate that neurons in the motor cortex and area 7a are processing different parameters of the stimulus depending on the kind of stimulus motion, and that this information is used in a predictive fashion in the motor cortex to trigger the interception movement.

## Concluding Remarks

The neurophysiological experiments on target interception revealed two fundamental issues regarding the use of a predictive strategy to control the interceptive behavior. First, the parietofrontal system of primates is engaged in the codification of target time-to-contact in the form of a constant increase in activity as a function of time during the interception of apparent motion targets. These tau-ramps, recorded in area 7a and particularly in the motor cortex, are a neural representation of  $TTC_{tar}$ , which may be used to trigger the interception action once it reaches a specific magnitude. The second critical observation is that the nervous system can use either spatial or temporal parameters to control the interception movement depending on the visual properties of the moving target. We found that in real visual motion the angular position of the target was the critical variable, whereas in the apparent motion condition it was  $TTC_{tar}$ . Thus, it is possible that the sequential flashing of apparently moving stimuli did not provide enough spatial information, and therefore, the motor system used instead the time-to-contact information to control the interception movement.

Overall, the behavioral and neurophysiological evidence suggest a fundamental framework for interceptive behavior in which the behavioral context and the spatio-temporal target kinematics, but also the accuracy requirements and subjective preferences define the strategy adopted to control the effector movement in a predictive fashion.

**Acknowledgments** We thank Dr. AP. Georgopoulos for his continuous support throughout the experimental part of the studies and during the writing of this chapter. We also thank R. Paulin and L. Gonzales-Santos for their technical assistance and Dorothy Pless for proof-reading the manuscript. The writing of this manuscript was supported by PAPIIT grant IN209305, FIRCA: TW007224-01A1, and CONACYT grant 47170.

## References

- Andersen RA. Neural mechanisms of visual motion perception in primates. *Neuron* 18: 865–872, 1997.
- Battaglia-Mayer A, Ferraina S, Genovesio A, Marconi B, Squatrito S, Molinari M, Lacquaniti F, Caminiti R. Eye-hand coordination during reaching. II. An analysis of the relationships between visuomanual signals in parietal cortex and parieto-frontal association projections. *Cereb Cortex* 11: 528–544, 2001.
- Bradley DC, Maxwell M, Andersen RA, Banks MS, Shenoy KV. Neural mechanisms of heading perception in primate visual cortex. *Science* 273: 1544–1547, 1996.
- Brouwer AM, Brenner E, Smeets JBJ. Hitting moving objects: The dependency of hand velocity on the speed of the target. *Exp Brain Res* 133: 242–248, 2000.
- Bruce C, Desimone R, and Gross CG. Visual properties of neurons in a polysensory area in superior temporal sulcus of the macaque. *J Neurophysiol* 46: 369–384, 1981.
- Cheng K, Fujita H, Kanno I, Miura S, and Tanaka K. Human cortical regions activated by wide-field visual motion: an H2(15)O PET study. *J Neurophysiol* 74: 413–427, 1995.
- Colby CL, Duhamel JR, and Goldberg ME. Ventral intraparietal area of the macaque: anatomic location and visual response properties. *J Neurophysiol* 69: 902–914, 1993.
- De Lussanet MHE, Smeets JBJ, Brenner E. The effect of expectations on hitting moving targets: Influence of the preceding target's speed. *Exp Brain Res* 137:246–248, 2001.
- Donkelaar P van, Lee RG, Gellman RS. Control strategies in directing the hand to moving targets. *Exp Brain Res* 91: 151–161, 1992.
- Duffy CJ, Wurtz RH. Sensitivity of MST neurons to optic flow stimuli. I. A continuum of response selectivity to large-field stimuli. *J Neurophysiol* 65: 1329–1345, 1991.
- Duffy CJ, Wurtz RH. Response of monkey MST neurons to optic flow stimuli with shifted centers of motion. *J Neurosci* 15: 5192–5208, 1995.
- Duffy CJ, Wurtz RH. Medial superior temporal area neurons respond to speed patterns of optic flow. *J Neurosci* 17: 2839–2851, 1997.
- Field DT, Wann JP. Perceiving time to collision activates the sensorimotor cortex. *Curr Biol* 15: 453–458, 2005.
- Fitts PM. The information capacity of the human motor system in controlling the amplitude of movement. *J Exp Psychol* 47: 381–391, 1954.
- Georgopoulos AP. Neural aspects of cognitive motor control. *Curr Opin Neurobiol* 10: 238–241, 2000.
- Gibson JJ. The ecological approach to visual perception. Houghton Mifflin Company, Boston, 1979.
- Gray R. Behavior of college baseball players in a virtual batting task. *J Exp Psychol Hum Percept Perform* 28:1131–1148, 2002a.
- Gray R. “Markov at the bat”: A model of cognitive processing in baseball batters. *Psychol Sci* 13: 543–548, 2002b.
- Hatsopoulos N, Gabbiani F, Laurent G. Elementary computation of object approach by a wide-field visual neuron. *Science* 270: 1000–1003, 1995.
- Indovina I, Maffei V, Bosco G, Zago M, Macaluso E, Lacquaniti F. Representation of visual gravitational motion in the human vestibular cortex. *Science* 308: 416–419, 2005.

- Johnson PB, Ferraina S, Bianchi L, Caminiti R. Cortical networks for visual reaching: physiological and anatomical organization of frontal and parietal lobe arm regions. *Cereb Cortex* 6: 102–119, 1996.
- Judge SH, Rind FC, The locust DCMD, a movement-detecting neurone tightly tuned to collision trajectories. *J Exp Biol* 200: 2209–2216, 1997.
- Lacquaniti F, Carrozzo M, Borghese NA. Time-varying mechanical behavior of multi-jointed arm in man. *J Neurophysiol* 69: 1443–1464, 1993.
- Lee DN. A theory of visual control of braking based on information about time-to-collision. *Perception* 5: 437–459, 1976.
- Lee DN, Reddish PE. Plummeting gannets: a paradigm of ecological optics. *Nature* 293: 293–294, 1981.
- Lee DN. Guiding movement by coupling taus. *Ecological Psychol* 10: 221–250, 1998.
- Lee DN, Georgopoulos AP, Clark MJ, Craig CM, Port NL. Guiding contact by coupling the taus of gaps. *Exp Brain Res* 139: 151–159, 2001.
- Lee D, Port NL, Georgopoulos AP. Manual interception of moving targets II. On-line control of overlapping submovements. *Exp Brain Res* 116: 421–433, 1997.
- Leon MI, Shadlen MN. Representation of time by neurons in the posterior parietal cortex of the macaque. *Neuron* 38: 317–327, 2003.
- Lisberger SG, Movshon JA. Visual Motion Analysis for Pursuit Eye Movements in Area MT of Macaque Monkeys. *J. Neurosci.* 19: 2224–2246, 1999.
- Marconi B, Genovesio A, Battaglia-Mayer A, Ferraina S, Squatrito S, Molinari M, Lacquaniti F, Caminiti R. Eye-hand coordination during reaching. I. Anatomical relationships between parietal and frontal cortex. *Cereb Cortex* 11: 513–27, 2001.
- Mason AH, Carnahan H. Target viewing time and velocity effects on prehension. *Exp Brain Res* 127: 83–94, 1999.
- Matelli M, Luppino G. Parietofrontal circuits for action and space perception in the macaque monkey. *Neuroimage* 14: S27–32, 2001.
- Maunsell JH, Van Essen DC. Functional properties of neurons in middle temporal visual area of the macaque monkey. I. Selectivity for stimulus direction, speed, and orientation. *J Neurophysiol.* 49: 1127–1147, 1983.
- Merchant, H., Battaglia-Mayer, A and Georgopoulos, A.P. Effects of optic flow in Motor Cortex Area 7a. *J Neurophysiol* 86: 1937–1954, 2001.
- Merchant H, Battaglia-Mayer A, Georgopoulos, A.P. Functional Organization of Parietal Neuronal Responses to Optic Flow Stimuli. *J Neurophysiol* 90: 675–682, 2003a.
- Merchant H, Battaglia-Mayer A, Georgopoulos, AP. Interception of real and apparent circularly moving targets: Psychophysics in Human Subjects and Monkeys. *Exp Brain Res* 152: 106–112, 2003b.
- Merchant H, Battaglia-Mayer A, Georgopoulos, AP. Neural responses in motor cortex and area 7a to real and apparent motion. *Exp Brain Res* 154: 291–307, 2004a.
- Merchant H, Battaglia-Mayer A, Georgopoulos, AP. Neural responses during interception of real and apparent circularly moving targets in Motor Cortex and Area 7a. *Cereb Cortex* 14: 314–331, 2004b.
- Merchant H, Battaglia-Mayer A, Georgopoulos, AP. Decoding of Path-Guided Apparent Motion from Neural Ensembles in Posterior Parietal Cortex. *Exp Brain Res* (2005) 161: 532–540, 2005.
- \*Merchant, H. and Georgopoulos, A.P. Neurophysiology of perceptual and motor aspects of interception. Review. *J Neurophysiol* (2006) 95: 1–13.
- Motter BC, Mountcastle, VB The functional properties of the light-sensitive neurons of the posterior parietal cortex studied in waking monkeys: foveal sparing and opponent vector organization. *J Neurosci* 1: 3–26, 1981.
- Mountcastle VB (1978) An organizing principle for cerebral function. In: *The mindful brain*, edited by Edelman GM and VB Mountcastle. Cambridge: MIT press, 1978, p. 7–50.

- Newsome WT, Britten KH, Salzman CD, and Movshon JA. Neuronal mechanisms of motion perception. *Cold Spring Harb Symp Quant Biol* 55: 697–705, 1990
- Phinney RE, Siegel RM. Speed selectivity for optic flow in area 7a of the behaving monkey. *Cereb Cortex* 10: 413–421, 2000.
- Port NL, Lee D, Dassonville P, Georgopoulos AP. Manual interception of moving targets. I. Performance and movement initiation. *Exp Brain Res* 116: 406–420, 1997.
- Rind CF, Simmons PJ. Seeing what is coming: building collision-sensitive neurons. *TINS* 22: 215–220, 1999.
- Shepard RN, Zare SL. Path-guided apparent motion. *Science* 220: 632–634, 1983.
- Siegel RM, Read HL. Analysis of optic flow in the monkey parietal area 7a. *Cereb Cortex* 7: 327–346, 1997.
- Sun H, Frost BJ. Computation of different optical variables of looming objects in pigeon nucleus rotundus neurons. *Nature Neurosci* 1: 296–303, 1998.
- Tresilian JR. Visually timed action: time-out for tau? *Trends Cognit Sci* 3: 301–310, 1999.
- Tresilian JR, Lonergan A. Intercepting a moving target: Effects of temporal precision constraints and movement amplitude. *Exp Brain Res* 142: 193–207, 2002.
- Tresilian JR, Oliver J, Carroll TJ. Temporal precision of interceptive action: Differential effects of target size and speed. *Exp Brain Res* 148: 425–438, 2003.
- Tresilian JR. The accuracy of interceptive action in time and space. *Exerc Sport Sci Rev.* 32: 167–173, 2004.
- \*Tresilian JR. Hitting a moving target: Perception and action in the timing of rapid interceptions. *Percept Psychophys* 67: 129–149, 2005.
- Tresilian JR, Houseman JH. Systematic variation in performance of an interceptive action with changes in the temporal constraints. *Q J Exp Psychol A* 58: 447–466, 2005.
- Van Essen DC, Maunsell JH, and Bixby JL. The middle temporal visual area in the macaque: myeloarchitecture, connections, functional properties and topographic organization. *J Comp Neurol* 199: 293–326, 1981.
- Wann JP. Anticipating arrival: Is the tau margin a specious theory? *J Exp Psychol Hum Percept Perform* 22: 1031–1048, 1996.
- Wise SP, Boussaoud D, Johnson PB, Caminiti R. Premotor and parietal cortex: corticocortical connectivity and combinatorial computations. *Annu Rev Neurosci* 20: 25–42, 1997.
- Zago M, Bosco G, Maffei V, Iosa M, Ivanenko Y P, Lacquaniti F. Internal models of target motion: Expected dynamics overrides measured kinematics in timing manual interceptions. *J Neurophysiol* 91: 1620–1634, 2004.
- \*Zago M, Lacquaniti F. Cognitive, perceptual and action-oriented representations of falling objects. *Neuropsychol* 43: 178–188, 2005.
- Zeki, SM. Functional organization of a visual area in the posterior bank of the superior temporal sulcus of the rhesus monkey. *J Physiol* 236: 549–573, 1974.
- Zeki S, Watson JD, Lueck CJ, Friston KJ, Kennard C, and Frackowiak RS. A direct demonstration of functional specialization in human visual cortex. *J Neurosci* 11: 641–649, 1991.

The references marked with an asterisk (\*) are specifically recommended for further introduction or background to the topic.